

Data Sheet

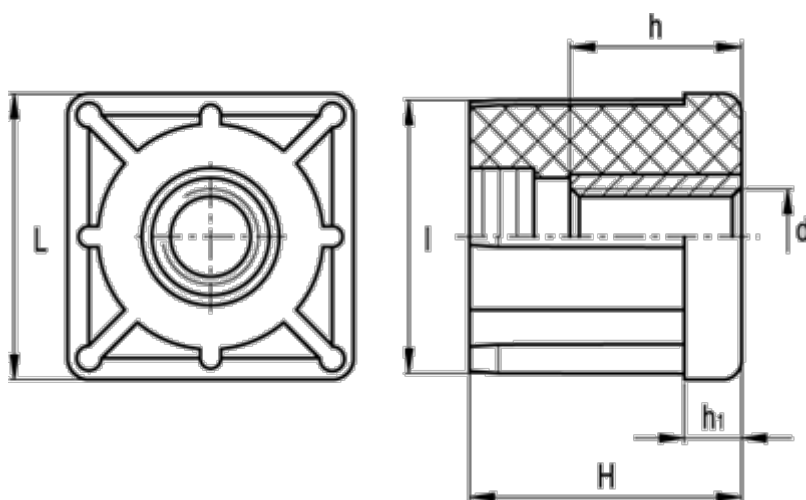

Article number: 2310320053
Description: E+G Square end-cap
NDX.Q-35x1.5-M12

Measures



d	= M12	Tube wall thickness = 1.5
h	= 10	Weight (g) = 40
H	= 38	
h1	= 8	
Internal tube size	= 32.0	
l	= 32.0	
L	= 35	
Outer tube size	= 35	